

Measure what you see.

micro-gloss



Manual

micro-gloss

Manual

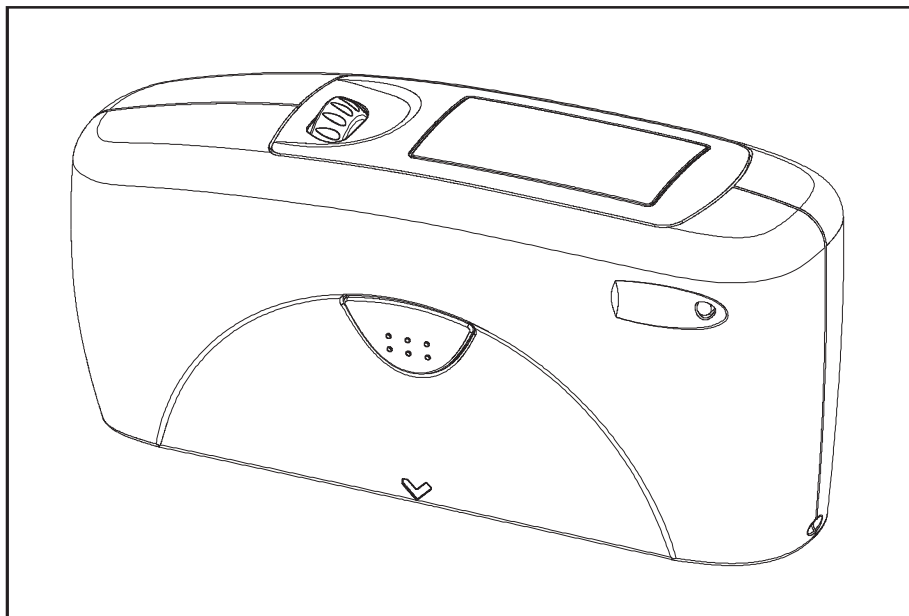

Patent pending

260 023 932 E 1604

BYK-Gardner GmbH

Lausitzer Str. 8
D-82538 Geretsried
Germany
Tel. 0-800-gardner
(0-800-4273637)
+49-8171-3493-0
Fax +49-8171-3493-140

BYK - Gardner USA

9104 Guilford Road
Columbia, MD 21046
USA
Phone 800-343-7721
301-483-6500
Fax 800-394-8215
301-483-6555

Dear customer,
thank you for having decided for a BYK-Gardner product. BYK-Gardner is committed to providing you with quality products and services. We offer complete system solutions to solve your problems in areas of gloss and physical properties. As the basis of our worldwide business, we strongly believe in total customer satisfaction. Therefore, in addition to our products, we offer many VALUE-ADDED services:

- Technical Sales Force
- Technical & Application Support
- Application and Technical Seminars
- Repair & Certification Service

BYK-Gardner is part of Altana AG and a direct subsidiary of BYK-Chemie GmbH, a leading supplier of additives for coatings and plastics. Together, we offer complete and unique solutions for you, our customer.

Thank you for your trust and confidence. If there is anything we can do better to serve your needs, do not hesitate to let us know.

Your BYK-Gardner Team

Table of content

1. Safety instructions	7
2. System description and Delivery notes	13
3. Power supply	15
3.1 Power supply battery-operated	15
3.2 Changing the battery	16
3.3 External power supply	16
4. Controls	17
5. Getting started	19
5.1 Turning on the unit and measuring	19
5.2 Navigation	20
5.3 Change names/numbers	21
5.4 Overview of main menu	22
6. Calibrate	23
6.1 Autodiagnosis	23
6.2 Calibrate	24
6.2.1 Gloss	24
6.2.2 Thickness (micro-TRI-gloss μ only).....	24
6.2.3 Change cal.values	25
6.2.4 Status	26
6.2.5 Scale Gloss	27
6.2.6 Scale Thickness	27
6.3 Calibrating standards	28
6.4 Checking standard	28
7. Measurement techniques	29
7.1 Paints and varnishes, plastics and similar materials	29
7.2 Anodized aluminum and other metal surfaces	30
7.3 Measurement of film thickness	31
8. Measurement Modes	32
8.1 Sample mode	32
8.2 Statistics	33

8.2.1	Number of measurements	34
8.2.2	Display	35
8.2.3	Exit block	36
8.2.4	Delete block	36
8.2.5	Delete measurement	36
8.3	Continuous	37
8.4	Basic mode	38
9	Geometry/Sensor	39
9.1	Geometry selection	39
9.2	Thickness Sensor selection	39
9.3	Sensor-setting Combi	40
10.	Memory/Organizer	41
10.1	Memory	41
10.2	Select memory	41
10.3	Create memory	42
10.4	Delete memory	42
10.5	Display memory	42
10.6	Select Organizer	43
11.	Difference measurement and Pass/Fail	45
11.1	Difference	45
11.2	Measure standard	45
11.3	Select standard	46
11.4	Create standard	47
Define standard	47	
11.5	Change standard	48
11.6	Delete standard	48
12.	Setup	49
12.1	Date/Time	49
12.2	Beeper	49
12.3	Display time	49
12.4	Language	50
12.5	Info	50
13.	Interface	51

14. Standards 52

15. Technical data 54

16. Errors and warning messages 56

17. Cleaning and maintenance 58

18. Service and Certification 59

Service 59

Service Centers for BYK-Gardner products 60

19. Copyright 61

1. Safety instructions

- Before operating the instrument the first time, please read the operating instructions and take particular notice of the safety instructions.
- If you use the unit and accessories properly, there are no hazards to fear.
- This product is equipped with safety features. Nevertheless, read the safety warnings carefully and use the product only as described in these instructions to avoid accidental injury or damage.
- No claims of product liability or warranty can be honored if the device is not operated in accordance with the operating instructions.
- Keep these instructions for future reference.
- If you pass this instrument to somebody else, make sure to include these instructions.

The following symbols and terms are used.



This symbol warns of the danger of injury.



This symbol warns of the danger of injury caused by electricity.



This sign points out additional information.

DANGER

The term **DANGER** warns of possible severe injuries and danger to life.

WARNING

The term **WARNING** warns of injuries and severe material damage.

CAUTION

The term **CAUTION** warns of slight injuries or damage.

DANGER injuries possible



- Defects and extraordinary loads
If safe operation can no longer be presumed, shut down the device and secure it against unintended operation.

The device must be presumed unsafe to operate:

- if visible damage is evident
- if the instrument is no longer working
- if it has been stored for long periods under adverse conditions
- after harsh treatment during shipping.



- Safety advices for batteries: Do not crush or dismantle, do not heat or incinerate, do not immerse in any liquid. This may cause explosion or release harmful substances.



- Do not perform any repairs on the unit yourself. The unit must be opened by trained professionals only. Please contact our customer service department in such cases.
- The measurement device may be disconnected from any power source as follows:
 - a) by removing the battery and/or
 - b) by disconnecting the USB-interface cable



- When working with the battery /rechargeable battery make certain there is no short circuit on the contacts. Metallic objects must not come in contact with the bare contacts.

WARNING severe material damage



- The measurement unit consists of sensitive optical and electronic precision parts. Prevent it from being dropped, bumped or shaken!
- Avoid exposure to continuous humidity and condensation. Avoid splashing with water, chemicals or other liquids.
- Please use only accessories that are available for the unit.
- Only devices that meet the requirements for low-voltage safety may be connected to the USB interface.

CAUTION material damage

- Do not allow any foreign objects to get into the measurement opening.
- Do not expose the unit to direct sunlight for extended periods of time. Do not store it in a hot or dusty environment. Use the instrument case for storage.
- Align the protective calibration holder when the instrument is not in use.

- Avoid prolonged high relative humidity and do not allow condensation water.
- **Do not use any acetone for cleaning the unit!** The unit housing is resistant to many solvents. For cleaning you should use a soft, moist cloth. Excessive dirt and dust can be removed with ethanol or cleaning alcohol.
- In case you intend not to use the instrument for a longer period of time, take out the battery.

Additional information on use:



- You will find the technical data for all system components on the respective manufacturer's plates and in the section Technical Data
- Batteries and rechargeable batteries are special waste and must therefore not be disposed of with household trash. Make certain to observe the disposal instructions of the battery or rechargeable battery manufacturer.

2. System description and Delivery notes

Measurement units of the micro-gloss family can be used to determine the gloss level of paint coatings, plastics, ceramics and metal surfaces. The micro-TRI-gloss μ additionally allows to measure the film thickness of paint and coatings on magnetic (Fe) and non-magnetic base metals (NFe).

Light is directed at the surface of the sample at a defined angle and the reflected light is measured photoelectrically (reflectometer).

Depending on the typical gloss level of the test object, reflectometers that direct light onto the surface at different angles (geometry) can be used.

Measurement units are equipped with standard geometries of 20°, 60° or 85°. All three of these geometries are integrated into the micro-TRI-gloss. Functions described in this manual in terms of geometry selection are only available with the three angle device.

In addition to measuring individual gloss values, it is also possible to record, save and statistically evaluate series of measurements consisting of up to 999 values.

The operate button and scroll wheel are used to control the system. System operation is supported by display messages (autodiagnosis and error messages).

The measurement unit conforms to the standards DIN 67530, ISO 2813, ASTM D 523 and BS 3900 Part D 5.

Instrument type:

micro-gloss 20°	4560
micro-gloss 60°	4561
micro-gloss 85°	4562
micro-gloss 45°	4567
micro-gloss 75°	4568
micro-TRI-gloss	4563
micro-TRI-gloss μ	4564
micro-gloss 60° S	4565
micro-TRI-gloss S	4566

Unit with small aperture:

micro-gloss 60° 2x4mm	4569
micro-gloss 60° S 2x4mm	4570

Comes complete with:

Measurement device, Protective holder with integrated calibration tile, Traceable certificate, USB-cable, Quick user guide and Safety instructions, Battery, Carrying case.

Additionally, Software smart-chart and Operating manual can be downloaded from the support section at:

www.byk.com/instruments

micro-TRI-gloss μ delivery includes additionally Fe and NFe zero standards.

Recommended accessories:

Checking standards for control of test equipment

for micro-gloss 20°	4422
for micro-gloss 60°	4462
for micro-gloss 85°	4487
for micro-gloss 45°	4458
for micro-gloss 75°	4459
for micro-TRI-gloss and micro-TRI-gloss μ	4434
micro-gloss 60° S	4464
micro-TRI-gloss S	4438
mirror type, highly reflective for 20°, 60° and 85°	4433

3. Power supply

Before operating the instrument for the first time, please read the operating instructions and pay attention to the safety instructions in Chapter 1.

Unpack the device and check to make certain all pieces have been included with delivery (for scope of delivery, see Section Delivery notes).

3.1 Power supply battery-operated

The battery must be placed in the measuring unit for operation service. The device runs on one AA 1.5-V alkaline or 1.2-V NiMH rechargeable battery.

Use only alkaline batteries or NiMH rechargeables (AA /LR6)!

Depending on the exact brand, the capacity of each battery is sufficient for about 3 000 measurements. When the battery voltage falls below the required minimum voltage in the course of operation, the following message appears on the display

Battery low!

To ensure that the unit is always ready for operation, it is recommended to have a spare battery handy, especially when performing measurements in the field.

3.2 Changing the battery

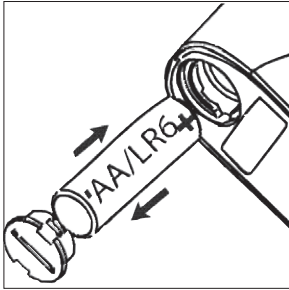

Changing the battery

To insert or change the battery open the battery compartment. The easiest way to do this is by turning the cover with a coin one-eighth of a rotation to the left. Turn the device back around and allow the old battery and the battery compartment cover to slide into your hand.

Insert the new battery with the positive (top) end first into the battery compartment and set the battery compartment cover in place again. Lock the cover by turning it one-eighth of a rotation to the right.

3.3 External power supply

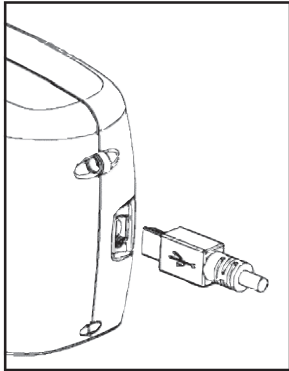

The instrument can be operated and supplied at a computer via USB-port. For the connection to the PC use the USB- cable included in the delivery.

Please refer to the chapter Interface for installation of the required software and drivers.

For power supply specification note the technical data.

4. Controls

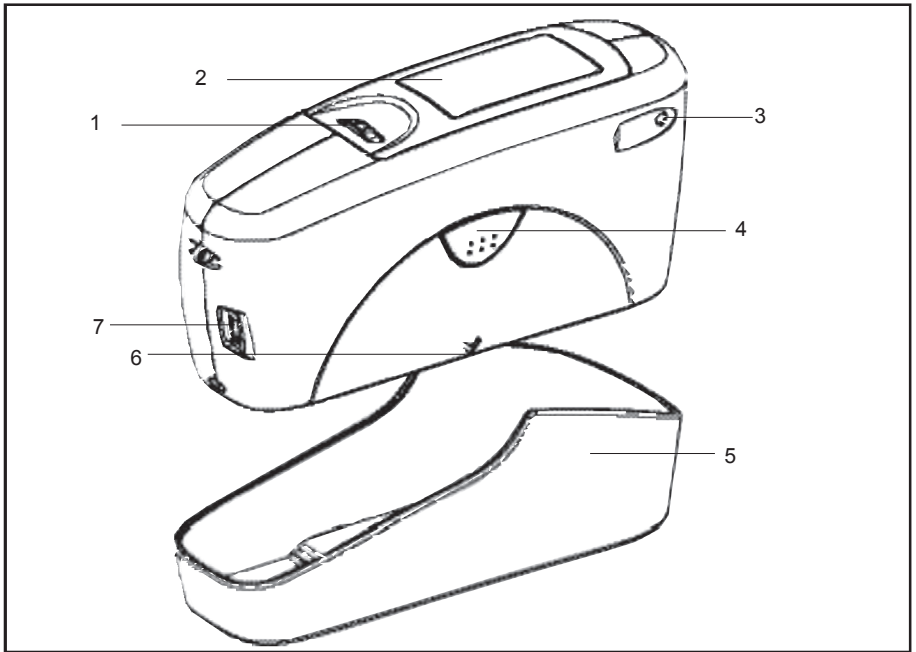

Measurement unit and protective holder

- 1 Mode scroll wheel: used to turn the unit on and for menu selection
- 2 Display for user guidance and displaying measurement values
- 3 Signal lamp:
green: measurement active
red: error
- 4 Operate button: used to activate measurements
- 5 Protective holder with integrated calibration standard
- 6 Mark for the measurement aperture
- 7 USB interface for connecting to a PC

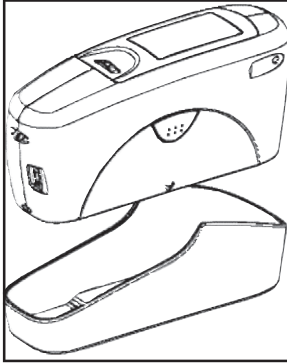

The basic system consists of the measuring device and the protective holder.

The protective holder is used for calibration and to store the measurement unit. Calibration is performed inside the holder automatically at the touch of a button. The gloss standard required for this purpose is kept in the holder and is positioned in such a manner that calibration is always performed at the same point.

When the device is turned on inside the holder, it performs a self-test (autodiagnosis).

If you will not be using the measuring unit, please store it in the protective holder. In this way the measurement optics are protected from dirt and dust and the calibration standard is always readily available.

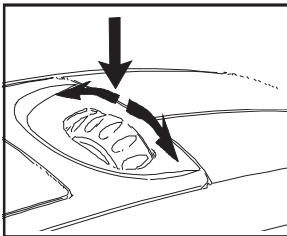

The operate button and scroll wheel are used to control the system. Pressing the wheel turns the unit on and causes a menu to be displayed. All settings within the menus are made by turning and pressing the wheel.

Pressing the operate button starts measurements or performs functions that are displayed. In addition, you can return from the various menus to mode with the operate button. System operation is supported by an autodiagnosis test, comments and error messages. Measurement values and comments appear in the display.

5. Getting started

5.1 Turning on the unit and measuring

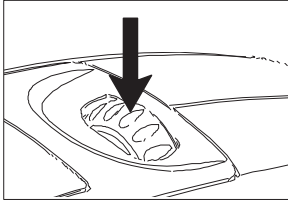

To turn on the unit, press the mode scroll wheel.

Information on the date and last certification appears in the display. If the device was turned on in its holder, the autodiagnosis test is performed (see the section on Calibration).

Autodiagnosis	
20°	OK
60°	OK
85°	OK

Then the unit switches into the last measurement mode to be selected.

Pressing operate initiates measurements.

A	B	C	D
M20°60°85°		SAMPLE 001	
STANDARD 1		In= 02/03	
	value	x	P / f
20°	56.5	56.3	FAIL
60°	82.9	82.4	Pass
85°	86.7	87.1	Pass
μm	63.9	63.3	Pass

The display of measurement results on the screen may be broken down into the following elements:

A: When Difference measurement is turned on, the name of the standard that is selected is displayed here.

B: If Memory is selected, the memory area that is selected appears at the top left and for

C: the sample name (block name).

D: If Statistics or Continuous is turned on, the number of measurements performed or selected is displayed here.

The measurement values appear in the lower part of the display area. The size of the numbers depends on whether Statistics or Difference measurement has been activated and on the number of geometries displayed. Depending on the measurement mode, a header line also appears for the measurement values.

5.2 Navigation

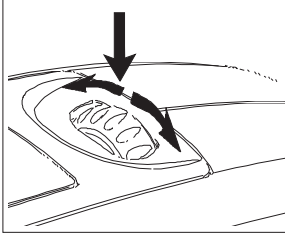

All control functions are controlled by the mode scroll wheel. Pressing the wheel causes a menu to appear in the display. Turning the wheel allows you to move the black mark to the desired function and to select or activate it by pressing the wheel.

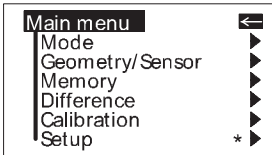

What functions are displayed in the menu depends on the settings in the main menu. The main menu is the “central” level and can always be reached quickly.

Certain rules apply within the menus to make it easier to navigate:

- ▶ A black triangle to the right of a function indicates that selecting this function will take you to a sub-menu.
- ✓ A check mark on the right indicates that the function in question has been activated.
- ← You can use the arrow at the top right to switch the display back by one level.



Arrows pointing up or down indicate that there are other menu options above or below the part of the menu that is visible. To reach these menu options, simply turn the scroll wheel in the direction in which the arrow is pointing.

You can quickly switch back from the menus to the measurement display by using the operate button. In some cases this button also has another function, but that will be indicated in the display (for example Confirm -> operate).

5.3 Change names/numbers

```
Display time
Seconds: 25
         ↑
Cancel --> [operate]
```

For some functions, you can enter or change the date or name. The arrow pointing upward marks the position that can be changed. To change the character, turn the scroll wheel. When you press the wheel, the arrow jumps to the next character.

After you have adjusted the last character or number, confirm your input by pressing the wheel.

```
Input name
SAMPLE 002
         ↑
Confirm --> [operate]
```

When you enter the name, the arrow jumps to the first character. This allows you to correct any inadvertent incorrect entries. You can confirm the name in these menus at any time with the operate key.

5.4 Overview of main menu

Mode

Sample mode	Measurement without statistical evaluation.
Statistics	Multiple measurement with statistics.
Continuous	Continuous measuring with adjustable interval.
Basic mode	Measuring without statistics, saving and difference.
Advanced mode	Reactivates all menus and functions when Basic mode was activated.

Geometry/Sensor

Select geometry and thickness sensor if applicable.

Memory/Organizer

Memory	Memory and Organizer functions: Turn saving on/off.
Select memory	Select memory area from list.
Create memory	Enter up to 50 memory areas.
Delete memory	Delete memory content or memory name.
Display memory	Recall of memory content (use scroll wheel).
Select Organizer	Choice of definable test sequences

Difference

Difference	Settings for difference mode: Turn difference measurement on/off.
Measure standard	Measure a standard.
Select standard	Select standard (if saved).
Create standard	Enter up to 50 standards and limits for Pass/Fail.
Delete standard	Delete individual standards.
Change standard	Enter/change limit values for Pass/Fail.

Calibration

Calibrate, change cal. values, GU - % scale.

Setup

Date/Time, Beeper, Display time, Language, Info

The following can be used together simultaneously:

- Memory with: Sample mode, Statistics, Continuous
- Difference with: Sample mode, Statistics

6. Calibrate

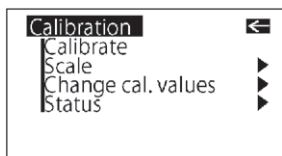

The holder with the integrated glass standard is used for calibration. Always keep the measurement unit in the holder. This protects the measurement optics and ensures that the standard is always at hand.

If you have several devices of this type, you must put the unit in the holder which belongs to the unit (see the serial number).

Make certain that the standard is clean and there are no cracks on it.

When you place the device in the holder, make certain that it ships firmly into place.

6.1 Autodiagnosis

Whenever you turn on the device in the holder, it first performs a self-test. During this test, any changes in the measurement signal are tested against saved calibration data. This allows for a long-term calibration so that a new calibration is required only about once a week. Beyond that, calibration is only necessary if there are significant weather changes (see under 6.2). It is recommended that you perform the self-test in the holder regularly (every day).

The autodiagnosis generally takes about 2 seconds. "Please clean standard" or "Please test standard" may be displayed. For more information on cleaning, see Chapter 17.

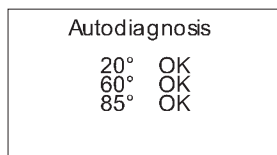

A message will appear in the display informing you that the autodiagnosis has been completed successfully.

In some cases, the system may suggest that you repeat the calibration. The reason for this may be changed ambient conditions. It is also possible, however, that the standard still has small amounts of residue left over from cleaning. This problem can generally be alleviated by cleaning with a dry optical cleaning cloth.

6.2 Calibrate

You should recalibrate the device if ambient conditions have changed. This applies especially when changing location if major changes in temperature and relative humidity may be expected as a result (for example inside/outside).

When moving from cold areas to warm areas, there is a danger of condensation. For this reason, after there has been a change in ambient conditions, you should wait for an appropriate amount of time to allow the optical components to adjust before calibrating and using the unit.

Main menu
▶ Calibration
▶ Calibrate
▶ **Gloss**

Use the path shown on the left side to reach the Calibrate menu option.

6.2.1 Gloss

Calibration	
20°	93.3
60°	95.7
85°	99.4

To begin calibration, press the scroll wheel.

The calibration process is performed automatically for all three geometries. The saved calibration values of the standard appear in the display.

The unit then returns to the selection menu Calibration.

Main menu
▶ Calibration
▶ Calibrate
▶ **Thickness Fe**
▶ Thickness NFe

You can use the path shown on the left side to reach the Calibrate Thickness option.

6.2.2 Thickness (micro-TRI-gloss μ only)

Calib. Thickness
Fe: ZERO
Continue -> [operate]

Choose the sensor (Fe, NFe) first.

In the display appears the menu for the calibration.

Put the instrument on the metal standard, according to sensor selection Fe or NFe, and press operate.

```

Calib. Thickness
Fe: AIR
Continue -> [ operate ]

```

After the zero setting has been performed, the display AIR will appear. To proceed with this, hold the instrument in midair and press the operate button.

The successful calibration is confirmed in the display (OK). The instrument returns to the selection menu Calibration.

Note:

The film thickness measurement is also influenced by the basis metal. It is therefore advisable to perform the zero calibration on the uncoated metal which is used for the object to be measured.

In this case place the instrument on your original substrate instead of on the supplied metal plate.

6.2.3 Change cal.values

The gloss values of the calibration standard in the holder included with delivery are saved in the measuring device. During automatic calibration, this data is assigned to the standard in the holder.

In some cases it will be necessary to enter data for a new calibration standard, for example if the previous standard has been damaged or scratched.

To ensure exact calibration, only original standards from the manufacturer should be used.

You can use the path shown on the right side to reach the Change cal.values menu option.

```

Main menu
└─ Calibration
  └─ Change cal.values

```

```

cal.value ←
├─ Change 20° value ▶
├─ Change 60° value ▶
└─ Change 85° value ▶

```

At three angle units, a selection menu will appear for geometries. Select the desired geometry and press the scroll wheel.

ATTENTION!

Calibration will be
changed!

Confirm → [mode]
Cancel → [operate]

A warning message appears. You can cancel this process by pressing the operate button.

If you press the scroll wheel, you will continue with the process of changing calibration values.

Change cal. value

20° 092.0
↑

Cancel → [operate]

In the next display you can enter new calibration values.

Change cal. value

20° 092.0

Confirm → [mode]
Cancel → [operate]

After you have entered the new value, a warning message appears again in the display. You can again abort the process with operate.

If you confirm the new value by pressing the scroll wheel, the value will be accepted.

After you have changed all necessary values, you should recalibrate the measurement device as usual.

6.2.4 Status

Status

		Last calib
20°	ERROR 02	01.01.04
60°	95.7	01.01.04
85°	99.4	01.01.04
Fe	OK	01.01.04
Nfe	OK	01.01.04

This menu item provides you with information on the calibration status of the unit.

In particular, you can check here whether the saved calibration values match those of the holder. The display also indicates if an error message was generated as a result of the last autodiagnosis or calibration. If this has happened, further information is available under Section Errors and warning messages.

Main menu
▶ Calibration
 ▶ Scale Gloss
 ▶ Scale Thickness

You can set the scales of the measurement values for gloss and thickness separately.

6.2.5 Scale Gloss

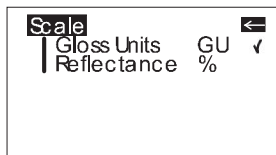

You can use the Scale menu option to switch back and forth between Gloss Units and Reflectance (see the Section on Practical measuring suggestions). Move the mark to the desired entry and press mode. A check mark identifies the Scale that is selected. After you switch the Scale, the unit must not be recalibrated.

6.2.6 Scale Thickness

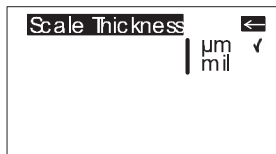

You can use the Scale menu option to switch back and forth between μm and mil. Move the mark to the desired entry and press mode. A check mark identifies the Scale that is selected.

6.3 Calibrating standards

To ensure exact calibration, only original standards from the manufacturer should be used.

These are calibrated against tested primary standards. Their surface must not be touched and must be protected against scratches. Due to environmental influences, however, the values of standards can change over the course of time even if they are handled gently. For this reason, you should have the calibration standards tested by the manufacturer at regular intervals (we recommend annually).

6.4 Checking standard

We recommend the regular use of a separate test standard for control of test equipment. The frequency of this verification depends on the conditions of usage (for example monthly). The gloss standards are integrated into an aluminum guide in which the measurement device is positioned exactly. Perform the measurement as you would normally, for example in Basic mode. The displayed measurement value must not deviate from the value printed on the standard by more than one unit. Otherwise you should check whether there is dirt and dust on the high gloss standard in the holder or test standard. If cleaning and recalibration do not offer any improvement, please get in touch with our Customer Service.

7. Measurement techniques

In accordance with the standard, the reflectometer value is related to a black glass standard at a defined index of refraction (generally 1.567) which is thus equal to 100 units.

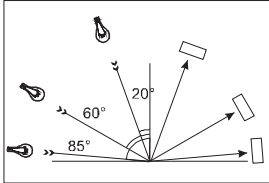

Reflectometers are differentiated by the angle of incidence of the illuminating mechanism. Geometries are set in the standards at 20°, 60° and 85°.

7.1 Paints and varnishes, plastics and similar materials

The various geometries are distinguished according to their fields of application as follows:

Semi-gloss surfaces are measured at an angle of incidence of 60° and should fall within a range from 10 to 70 gloss units.

Highly reflective surfaces with measurement values exceeding 70 units in the 60° geometry should be measured at 20°.

On the other hand, matte surfaces with less than 10 gloss units (at 60°) should be measured at the 85° geometry.

In addition, specific measuring geometries are defined in some industries, e.g. ceramic and plastic film applications recommend 45° geometry or paper and vinyl housing facades use 75° geometry.

7.2 Anodized aluminum and other metal surfaces

The measuring unit is equipped with an extended measuring range for measuring samples with a very high reflectance.

The reflectance of non-metallic surfaces increases with the angle of incidence. The reflective properties of metals do not always behave in this manner. Because of double reflection, the light is partially reflected on the coating and partially on the metal underneath. For a complete understanding of the reflective properties of such surfaces, it is recommended to measure them at all geometries.

In addition to the reference to a black glass standard (gloss units), it is also common in the area of metals to relate the reflectometer value to the amount of irradiated light and to express it as a % (reflectance). You can select this in the Scale menu.

Main menu
▶ Calibration
▶ **Scale**

Notes

Proper measurements are only possible on level surfaces.

Measurements on dirty, scratched or otherwise distorted areas of the test specimen are not meaningful except as a way of determining the degree of such imperfections by means of a gloss measurement.

Since it cannot be assumed that the gloss capacity is not constant over the entire surface of the test specimen, the reflectometer value can be measured at several different places and the standard deviation can be determined.

If the sample exhibits structures or directionally dependent gloss properties, the structural features and the direction of the incident light should be specified for the measurement in the test report.

Samples that must be measured several times over the course of an examination (for example weathering samples) should be marked accordingly to ensure that the measurement is made at the same point during repeated tests.

7.3 Measurement of film thickness

The film thickness sensor functions according to the magnetic method (Fe) or the eddy current method (NFe). Therefore, the measurement results can be distorted by strong magnetic fields or electromagnetic radiation.

The measurement of film thickness is influenced by the thickness and magnetic (Fe) or electrical (NFe) properties of the basis metal.

The measurement results can thus be distorted by such factors as the composition or heat treatment of the substrate. It is therefore advisable to perform the zero calibration on the uncoated metal which is used for the object to be measured.

Surface roughness also influences the measurement of the coating thickness. To reduce random errors, multiple measurements are recommended.

If the paint film thickness is to be measured using a magnetic substrate coated with a non-iron metal (e.g. zinc plated steel sheet), the following must be noted:

- For the NFe setting, the thickness of the substrate, i.e. of the non-magnetic coating, must be at least 50 μm .
- With the Fe setting, the thickness of the non-magnetic coating is included in the measurement result.

8. Measurement Modes

You can select different types of measurement in the Mode menu. The mode that is activated is identified by a check mark.

8.1 Sample mode

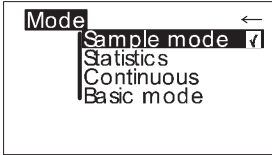

Single measurements can be performed without statistical evaluation in Sample mode.

The results can be saved and compared with a standard (refer to Memory or Difference).

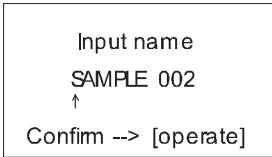

When Memory is turned on, a name is suggested after every measurement. You can confirm this name directly or change it.

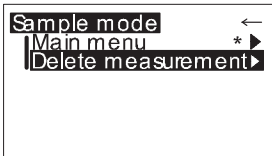

If you would like to delete the last measurement, press the scroll wheel and select the appropriate menu item.

8.2 Statistics

```
Main menu
▶ Mode
  ▶ Statistics
```

You can make multiple measurements with each sample in Statistics mode. These measurements will be evaluated statistically and displayed.

	value	\bar{x}	stdev	n= 02/03
20°	54.7	54.1	0.3	
60°	81.6	82.1	0.2	
85°	86.7	86.9	0.4	
µm	61.2	63.5	1.2	

The results can be saved and compared with a standard. These functions must be previously activated (refer to Memory or Difference).

```
Input name
SAMPLE 002
↑
Confirm --> [operate]
```

When Memory is turned on, a name is suggested after all measurements of a sample (block). You can confirm this name directly or change it.

```
Statistics
Main menu *
Number of meas. ▶
Display ▶
Exit block ▶
Delete block ▶
Delete meas. ▶
```

When the Statistics function is turned on, additional functions are available depending on the context after you press the scroll wheel.

Note:

(micro-TRI-gloss μ only)

When STATISTICS is activated, all film thickness values are stored in the Memory independently of the sonde used.

In the case of an incorrect substrate or a high film thickness, "Infi" is written to the memory.

When the instrument is switched off, the last setting remains active.

8.2.1 Number of measurements

Number of readings
per mean value

n= 03

↑

Cancel --> [operate]

You can adjust the number of measurements per sample or per block with this option, from 2 - 99.

	value	\bar{x}	stdev	n= 02/03
20°	54.7	54.1	0.3	
60°	81.6	82.1	0.2	
85°	86.7	86.9	0.4	
μm	61.2	63.5	1.2	

You can find this value in the measurement display by looking for "n=" after the forward slash. The number of measurements (which increases by one each time a measurement is performed) appears before the slash.

8.2.2 Display

In the Statistics measurement display, you can assign the following data freely to three columns:

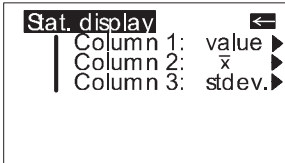

Value:
Last value to be measured

Mean value:
Arithmetic mean of the sample (block).

Maximum:
Highest measurement value of the sample

Minimum:
Lowest measurement value of the sample

Range:
The difference between the maximum and minimum value.

Std. Dev.:
The standard deviation of the sample

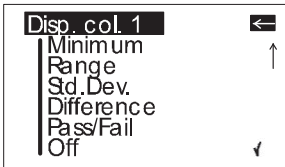
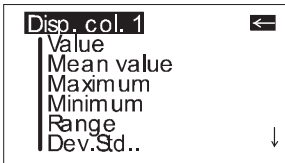

Difference*:
The difference between the sample and a target value.

Pass/Fail*:
Pass is displayed if the sample value falls within the specified limits, or Fail if it falls outside.

Off:
Turns off the display of the selected column.

$$s = \sqrt{\frac{1}{n-1} \sum_{i=1}^n (x_i - \bar{x})^2}$$

* To be able to use these functions, a standard must be measured, created or selected. In particular, a limit value must be defined.

8.2.3 Exit block

Statistics

- ▶ Exit block
- ▶ Delete block
- ▶ Delete meas.

This function terminates the block before it reaches the required number of measurements n. It is useful if you have selected a high number of measurements for n, for example in the case of large samples.

Input name
SAMPLE 002
↑
Confirm --> [operate]

If Save is turned on, a display appears to enter a block name for the sample.

8.2.4 Delete block

Delete block
SAMPLE 023
Confirm --> [mode]
Cancel --> [operate]

This function deletes the current block.

8.2.5 Delete measurement

This function deletes the last measurement value.

8.3 Continuous

Main menu
 ▶ Mode
 ▶ Continuous

Continuous

▣ Start: operate
 ▣ Pause: hold operate
 □ Stop: hold mode

You can use this function to perform up to 99 measurements at an adjustable measurement interval. This is helpful when you are covering large samples and you want to evaluate the homogeneity of the surface.

Activate Continuous under Mode from the Main menu.

A screen appears for starting a new sequence.

▣	20°	54.7
	60°	81.6
	85°	90.3

To start the measurement, press operate. The unit now performs measurements up to 99 times at the set interval. Measurement values are shown in the display after each measurement.

▣	\bar{x}	n=25/99	
		min	max
	20°	48.9	50.4
	60°	79.5	81.5
	85°	85.3	86.1

You can interrupt the continuous measurement by pressing the operate button (hold it down briefly). The number of measurements, the mean value, the minimum and the maximum appear in the display. The Pause symbol on the left side indicates that you can continue the sequence, therefore press the operate button.

□	\bar{x}	n=25/99	
		min	max
	20°	48.9	50.4
	60°	79.5	81.5
	85°	85.3	86.1

To end the sequence, press mode.

For starting a new sequence, press operate again

Input name
 SAMPLE 002
 ↑
 Confirm --> [operate]

If saving is activated, a screen appears at start of a new sequence, which allows to enter a sample name.

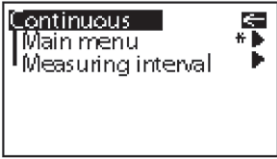

The measuring interval can be changed before a sequence is started. Therefore press the mode wheel to open the Continuous submenu.

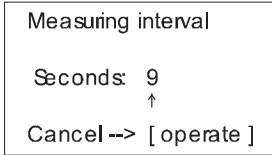

The longest measurement interval possible is 9 seconds, the shortest 0 seconds for continuous measuring. The interval slightly increases when thickness sensor is activated.

8.4 Basic mode



The selection options are limited to the most essential in Basic mode. This also greatly simplifies operation in this mode.

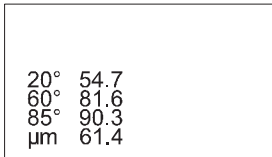

You can select geometry and thickness sensor and perform calibration. In addition, all functions in the Setup menu item are available.

Basic mode is useful if you want to interrupt a series of measurements and quickly perform some other measurements in the middle without leaving the series of measurements.

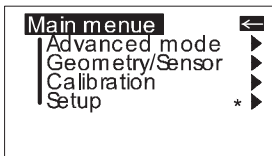

Once these other measurements are complete, you can use



to return to the point where you interrupted the series of measurements.

9 Geometry/Sensor

Main menu
 ▶ Geometry/Sensor

In this menu, you can select the geometry for the gloss measurement, just as the sensor for the film thickness measurement (at micro-TRI-gloss μ).

9.1 Geometry selection



Choose Gloss Geometry from the Geometry/Sensor menu.

You can choose between the representation of one, two or all three geometries in the display.

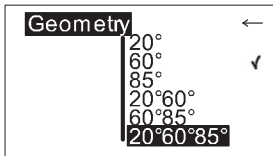

The currently set angle combination is indicated in the Geometry menu by a check mark.

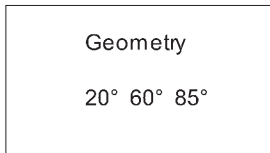

Select the desired combination with the scroll wheel and then confirm by pressing mode.

When Save is turned on, switching the geometry automatically causes the program to switch to the appropriate predefined area of memory.

9.2 Thickness Sensor selection

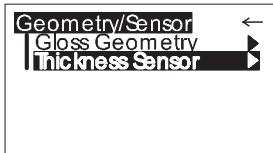

The currently selected sensor is indicated in the display by a check mark.

Off

The film thickness sensor is switched off.

Fe

Magnetic base metal (iron or steel)

NFe

Non-iron metal (e.g. aluminium)

Combi

When changing the substrate, the sensor will be switched over automatically

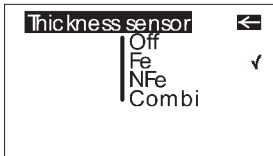

Choose the desired sensor with the scroll wheel. Press mode to confirm the desired selection. The selected sensor is indicated in the display.

Note:

The measurement unit can be selected in μm or mil for display (see section Calibration: Scale Thickness).

9.3 Sensor-setting Combi

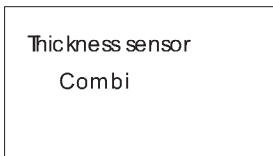

When switching the Thickness setting to Combi, the measurement will be run through in the sequence Fe - NFe.

As the measurement takes place on a ferromagnetic substrate, the procedure will be finished directly after the Fe measurement.

With the measurement on a non-magnetic substrate the sequence will go through and therefore lasts somewhat longer.

Note:

When STATISTICS is activated, all film thickness values are stored in the Memory independently of the sonde used.

In the case of an incorrect substrate or a high film thickness, „Infi“ is written to the memory.

When the instrument is switched off, the last setting remains active

10. Memory/Organizer

Main menu

►Memory

To save measurement values, you must activate the Memory function before measuring or else select or create a memory. Up to 999 measurements can be stored. A fixed memory area is already created for each geometry or combination (e.g. M60°). These memory areas cannot be deleted. A total of 50 memory areas can be created.

The Memory function can be used for sample mode, Statistics and Continuous measurements. The layout of the memory is such that the measurement mode and the standard can be changed within a memory area, but not the geometry.

10.1 Memory



You can use this function to turn saving on or off. A check mark indicates if the function has been activated.

Turning on Memory automatically selects the area in memory that is predefined for the currently set geometry (for example M20°60°).

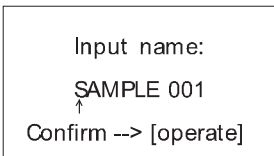

When you press operate to start a reading, you are asked to enter a name for this memory.

10.2 Select memory

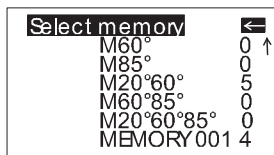

All available areas of memory are listed in this menu, beginning with the one that is predefined.

The number of measurements saved for each area in memory is shown on the right.

Select the appropriate memory area with the scroll wheel and activate the selection by pressing mode.

This automatically turns on Save and switches the geometry if necessary (if the selected memory area is defined for other geometries than what was previously set).

10.3 Create memory

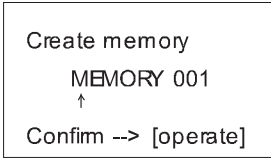

Users can set up their own memory areas with this function. Select the required geometry before you activate this function. Then you must enter the name of a memory area. You can confirm the suggested name directly with the operate button or change it with the scroll wheel. After you confirm, Save is automatically turned on.

10.4 Delete memory

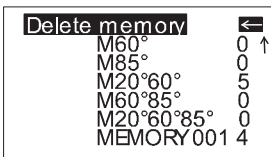

This menu lists all memory areas that have been created with the number of values stored in each one.

Use the scroll wheel to move the mark to the memory area you would like to delete and press the wheel.

Delete

- ▶ Measurements
- ▶ Memory

A menu appears in which you can decide whether you would like to delete just the content of the memory area or the entire memory area.

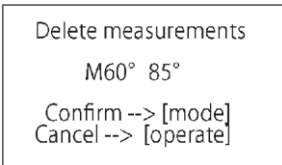

For pre-defined memory areas, you can only delete the measurement values.

10.5 Display memory

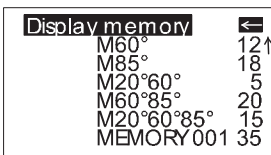

You can transfer data that has been saved to a PC via the interface. The values can also be shown in the display at any time.

The “Display memory” function opens a menu in which all memory areas that have been created are listed. Select the desired area of memory with the scroll wheel.

M20°60°		SAMPLE005
20°	45.1	
60°	72.3	
µm	66.4	

The values of the first measurement appear in the display. The sample name is displayed in the highlighted field.

The values displayed in the columns depend on the currently selected statistics settings.

Turning the wheel switches the display to the next sample with its corresponding values.

10.6 Select Organizer

Memory/Organizer	←
Memory	√
Select memory	▶
Create memory	▶
Delete memory	▶
Display memory	▶
Select Organizer	▶

This function is available if „Organizer“ files are loaded to the instrument. An organizer defines a test sequence for measuring e.g. a car body with several checkzones. Such files can be created with the software „smart-process“.

Select parameter 1	←
Model 1	
Model 2	
Model 3	

In a first step, the function allows to select previously defined parameters to identify the test object, e.g. model names. Additional menus appear for selection of a second and third Parameter, e.g. color and paint line.

After selection, the unit goes to the measurement sequence.

Model 1	Hood Mid
	n=02/03
20°	89.3
60°	92.7

In the upper left corner of the display, the name of the first parameter appears. The name of the checkzone to be measured first is shown on the upper right side. Below, the number of performed and predefined readings is displayed (e.g. n=02 of 03).

Once the number of readings is reached, an audio signal is heard and the display shows the results of the measurement. Pressing briefly the operate button allows the next checkzone to appear in the display.

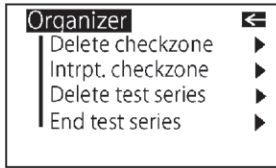

Additional functions are available by pressing the scroll wheel. A menu appears which allows to:

- Delete the last checkzone,
- interrupt a checkzone and skip to the next,
- interrupt and end the test series.

Note:

If Interrupt is deactivated in the organizer, it is necessary to finish the complete test sequence, i.e. you can exit a series only by deletion.

If all checkzones have been measured, the instrument returns to the Memory menu.

The data are saved in the unit and can be transferred to the smart-process software for further analysis and documentation.

11. Difference measurement and Pass/Fail



You can compare the readings of samples with the value of a previously measured or saved standard.

For saved standards, you can also display whether the test specimen falls within the limits (Pass) or outside (Fail).

Up to 50 standards can be saved. They are stored in a separate area of memory. For each geometry you can determine:

- A target value
- Maximum and minimum for Pass/Fail, see Create standard or Change standard.

11.1 Difference

You can use this menu option to turn Difference measurement on or off. A check mark indicates if the function is active.

When you turn on Difference, the last standard to be used is automatically selected.

If no standard is available, choose the function "Measure standard" or "Create standard" to continue.

11.2 Measure standard

We recommend to perform several readings on the standard with Statistics turned on.

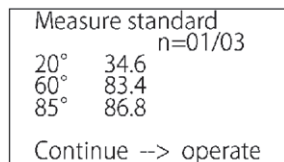

Memory must be activated to store the measured standard. Otherwise it will be temporary hold until another standard is measured.

Activate "Measure standard" and perform the measurement with operate. With memory on, a window appears after the last reading where you can enter the standard's name.

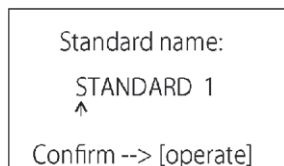

If you inadvertently select a name that has already been used, a message will appear in the display and the arrow will jump back to the first position of the name.

The measured standard values are saved as the target values. At the same time, Difference measurement is turned on and the measured standard is activated. If you want to define limit values additionally, you can use the “Change standard” function.



For measuring the samples continue by pressing operate. The display shows the sample values and difference to the target.

The Measure standard function can also be reached directly from the measurement screen by pressing mode.

If you want to compare samples without saving the standard, use the Difference mode with Memory switched off. A measured standard will be kept temporary then, until you measure another one.

11.3 Select standard



To select an existing standard, use the arrow to move the mark to Select standard and then press the wheel.

Standard	Val.	Min	Max
20°	45.0	40.0	50.0
60°	80.0	80.0	90.0
85°	0.0	0.0	2000

The first standard appears in the display. The target value, minimum and maximum are displayed. For values that are not defined, 0.0 or 2000 is displayed. The name of the standard appears inverted at the top right.

Turning the scroll wheel causes the next standard to be displayed.

When you have selected the desired standard in the display, activate it by pressing on the wheel.

A reference to the selected data will appear in the display.

To start Difference measurement press “operate“.

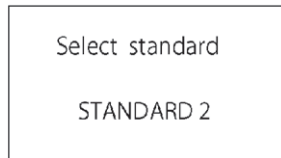

11.4 Create standard

Main menu

- ▶ Difference
 - ▶ Create standard

Standard name:
 STANDARD 1
 ↑
 Confirm --> [operate]

Standards can also be saved by entering the target and limit values with the scroll wheel. Move the mark to “Create standard” and activate the function.

A display appears in which you must assign a name for the new standard. If you inadvertently select a name that has already been used, a message will appear to this effect and the marker arrow will jump back to the first position of the name. Confirm the name with the operate button.

In the next step you can define the target and limit values of your standard.

Define standard

Define standard
 20°
 60°
 85°
 Thickness

With the three angle device, a menu first appears in which you can select the geometry.

Define standard
 Target value
 Minimum
 Maximum

After that, the menu appears for selecting the target value, minimum and maximum.

Select the desired variable and press on the scroll wheel.

Define standard
 STANDARD 5

 Value 20° 0000.0
 ↑
 Cancel --> [operate]

Now you can adjust the corresponding value.

After the last number is activated, the display jumps back to the previous menu.

In this manner you can enter additional target and/or limit values for the standard one after the other if need be. After the entries are complete, Difference measurement is turned on with the new standard.

11.5 Change standard

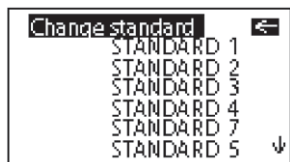

You can use this function to change target values and limit values of saved standards. You can also use it to define limit values subsequently (for example for a measured standard). Use the scroll wheel to move the mark to Change standard and press the wheel.

All standards are listed one after the other in the following menu. Select the desired standard and press the scroll wheel.

In the next step you can define the target and limit values as described above.

11.6 Delete standard

Use the selection wheel to move the mark to Delete standard in the Difference menu and then press the wheel.

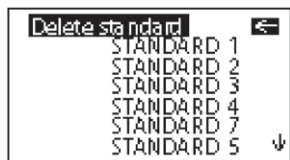

The Delete standard menu appears. All saved standards are listed in this menu.

If there are more standards than can be shown in the display, arrows on the right edge of the display will point to additional standards.

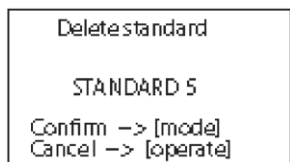

Use the scroll wheel to move the mark to the desired standard and press the wheel.

The standard to be deleted is listed again in the display. Confirm by pressing the mode scroll wheel.

The unit then reverts to the previous menu.

12. Setup

Main menu
▶ Setup

You can make general settings in the Setup menu, for example Language or Display time.

12.1 Date/Time

```
Date/Time
03.03.16 11:45:37
↑
Confirm -->[operate]
```

The unit contains an integrated clock. This makes the date and time of the measurement available for data transfer to a PC. The date and time are not lost even when the battery is changed. If you would like to change the time setting, use the scroll wheel to move the mark to Date/Time and then press mode. The display for setting the date and time appears.

12.2 Beeper

You can use this menu option to turn the beeper on or off. Use the scroll wheel to move the mark to Beeper and press the wheel.

When the beeper is turned on, a check mark appears at the end of the line.

12.3 Display time

```
Display time
Seconds: 25
↑
Cancel ---> [operate]
```

To save electricity, the unit automatically turns off after a certain amount of time. You can determine this time yourself with Display time.

12.4 Language



You can use this menu to select the display language.

Use the scroll wheel to move the mark to the desired language and press the wheel.

12.5 Info



You can use this menu option to find the following information:

- Catalog No.
- Serial No.
- Version number of the firmware
- Date of the last calibration
- Date of the last certification

13. Interface

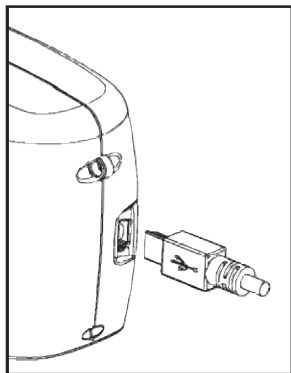

The measurement device is equipped with a USB interface that allows direct communication with a PC.

For data transfer use the USB cable included with delivery. Measurement data can be transferred into the smart-chart program. The data are displayed immediately in a test report with trend graph.

The smart-chart software can be downloaded from the support section at:

www.byk.com/instruments

14. Standards

ISO 2813	Paints and varnishes - Determination of gloss value at 20°, 60° and 85°
ASTM D 523	Standard Test Method for Specular Gloss
ASTM D 2457	Standard Test Method for Specular Gloss of Plastic Films and Solid Plastics
DIN 67530	Reflektometer als Hilfsmittel zur Glanzbeurteilung an ebenen Anstrich- und Kunststoffoberflächen (Reflectometer as a means for gloss assessment of plane surfaces of paint coatings and plastics)
BS 3900 - D5	Methods of test for paints. Measurement of specular gloss of non-metallic paint films at 20°, 60° and 85°
JIS Z 8741	Method of Measurement for Specular Glossiness
ISO 7668	Anodized aluminium and aluminium alloys - Measurement of specular reflectance and specular gloss at angles of 20°, 45°, 60° or 85°.
BS 6161 - 12	Methods of test for anodic oxidation coatings on aluminium and its alloys. Measurement of specular reflectance and specular gloss at angles of 20°, 45°, 60° or 85°.

ISO 2178	Non-magnetic coatings on magnetic substrates - Measurement of coating thickness - Magnetic method
ISO 2360	Non-conductive coatings on non-magnetic electrically conductive basis materials. Measurement of coating thickness. Amplitude-sensitive eddy-current method.
ASTM B 499	Measurement of Coating Thicknesses by the Magnetic Method: Nonmagnetic Coatings on Magnetic Basis Metals
ASTM D 1400	Measurement of Dry Film Thickness of Nonmetallic Coatings of Paint, Varnish, Lacquer, and Related Products applied on a Nonmagnetic Metal Base
Tappi T 480	Specular gloss of paper and paperboard at 75°

15. Technical data

General technical data

Temperature range	+15 °C to +40 °C (60°F to 104°F) for operation - 10 °C to +60 °C (-14°F to 140°F) for storage
Rel. humidity	Up to 85% non-condensing

Measurement unit:

Memory	999 measurements with date and time, in up to 50 memory areas
Difference measurement	Memory for 50 references
Interface	USB
Evaluation software	smart-chart
Power supply	1 Mignon Alkaline (AA/LR6) or rechargeable NiMH
Battery	1.5VDC, max. 0.1A
Rechargeable	1.2VDC, max. 0.1A
External power supply	USB, 5VDC, max. 0.1A
Dimensions (WxLxH)	48 x 155 x 73 mm
Weight	400 g

Gloss measurement:

Measurement geometry	20°	60°	85°	45°	75°
Measurement area (mm)	10 x 10	9 x 15*	5 x 38	9 x 13	7 x 24
Measurement range	0-2000GU	0-1000GU	0-160GU	0 – 180GU	0 – 140GU
Color sensitivity	in spectral adjustment to CIE luminosity function $\bar{y}(2^\circ)$ under illuminant CIE-C				

Accuracy

Range	Repeatability	Reproducibility
0 - 100 GU	0.2 GU	0.5 GU
100 -2000 GU	0.2 %	0.5 %
S - type units:		
0 - 10 GU	0.1 GU	0.2 GU

* units with small opening 2x4 mm

Film thickness measurement:

Substrate	Fe: magnetic, e.g. iron NFe: non magnetic, e.g. aluminium
Sonde	One point
Measurement range	0...500 μm (0 ... 20 mil)
Accuracy	$\pm(1.5\mu\text{m} + 2\%^{*})$ *of measured value
Min. substrate thickness	Fe: 0.20 mm (8 mil) NFe: 0.05 mm (2 mil)

Specifications subject to change without notice.

16. Errors and warning messages

Memory full	Transfer the content of memory to a PC and then delete the contents of memory.
Reference memory full	A maximum of 50 references can be saved. It may be necessary to delete old references.

You will also find an error number for the following messages in the Calibration/Status menu to provide support for diagnostics:

Tolerance Error 01	Generally occurs only with major changes in climatic or weather conditions. The deviation was successfully compensated for by calibration and correct measurements are still possible. You should still recalibrate the device as soon as it is operating in normal climatic conditions again. However if a change in climate cannot be considered as the cause of the problem, you should check whether the standard is clean.
Please call Service	Autodiagnosis has determined an impermissible Service (invalid) deviation in the measurement signal that cannot be remedied by recalibrating.
Error 02	Generally occurs when there is a significant amount of dirt or dust on the standard or optics. First try to clean the standard. You should only have the optics cleaned by our Customer Service department, for example as part of a yearly recertification.
Error 03	Defect in the electronics or operating error. First check whether the standard is clean and whether the device is properly snapped into the holder.
Error 04	Defect in the lamp or electronics.
Error 05	Defect in the electronics.
Inf	Wrong basis metal, measurement range exceeded or calibration error; recalibrate, if necessary.

Error Thickness

Operating error: improper application, raising before measurement is complete, or calibration error. Repeat the procedure.

If the error is shown repeatedly despite correct operation and calibration, please contact our customer service department.

Please observe the instructions on cleaning standards in the section on Calibration.

Fluctuations in measurement values

Was the same point on the sample used for all measurements?



Yes. It may help to test the calibration with an additional standard if one is available.



Calibration correct:

Is the test surface completely even and does the measuring device have good contact with the sample?



Yes: Device defective

→ **No.** Check how high the deviations are on the sample itself.

→ **Calibration not correct:**
Recalibrate and clean the standard if necessary.

→ **No:**
In this case, major deviations are possible.

→ Please contact our Customer Service department.

Do not attempt to make any repairs yourself! If a malfunction occurs on your measuring device, our Customer Service department will be happy to help you as quickly as possible.

17. Cleaning and maintenance



- Do not insert any objects into the measurement aperture for cleaning. The instrument could get damaged - affecting a proper and safe operation.



- The instrument housing is resistant to a number of solvents, but cannot be guaranteed to withstand all chemicals. You should therefore use a soft, moist cloth for cleaning. For cleaning excessive dirt, use ethanol or cleaning alcohol. **Do not use any acetone!**



- **Cleaning standards**

The accuracy of the measurement can be significantly impacted by using dirty or damaged standards.

Since the surfaces of the standards are highly sensitive, cleaning must be undertaken with great care.

To clean standards, use a new lint-free cloth, dust-free lens paper or an optical cloth.

Apply only slight pressure as you clean and make certain there are no large particles stuck in the cloth that could damage the surface. **Do not use any acetone!**

For dirt that is difficult to remove, use an optical cloth dipped in liquid. Then wipe the surface with a dry optical cloth.

Exact calibration is not possible unless the standard is in perfect condition. If the condition of the standard seems doubtful because of its appearance or measurement errors, we will be happy to check it for you.

18. Service and Certification

Service

Besides the repair of your instrument we offer the following additional services:

First diagnosis on the telephone or by e-mail

Call us or send us an e-mail and we will try to solve your problem. If this is not successful, please send us the instrument for repair.

Preventive maintenance, calibration, and recertification

For precautionary reasons we recommend regular preventive maintenance. We carry out this preventive maintenance automatically when you send us your instrument for maintenance and recertification. We clean the optics, check all functions, test and, if required, adjust the measured values by using reference standards. You will receive a certificate, which includes the retraceability to international standards.

Loaners

During the period of repair we furnish you with a loaner on request and availability.

Maintenance agreement

In case you want to make sure that the necessary maintenance is being done on a regular basis and on time, we recommend a maintenance agreement.

Extended warranty contracts

Furthermore, you can request an extended warranty contract for additional 12 months.

Service Centers for BYK-Gardner products

Germany

BYK-Gardner GmbH
Lausitzer Strasse 8
82538 Geretsried
Germany
Phone: +49-8171-3493-0
Fax: +49-8171-3493-166

USA

BYK-Gardner USA
9104 Guilford Road
Columbia, MD 21046
USA
Phone: +1-301-483-6500
Fax: +1-301-483-6555

China

BYK-Gardner Shanghai Office
6A Building A, Yuehong Plaza
No. 88 Hongcao Road
Shanghai 200233
P.R. China
Phone: +86-21-3367-6325
Fax: +86-21-3367-6305

19. Copyright

This instruction manual is an important part of this instrument. It contains essential information about setting up, placing in service and use. If you pass the device on to another user, please ensure that the instruction manual is included with the instrument. The manual must be studied carefully before working with the equipment. Please contact your regional service office if you have any questions or require additional information about the device.

The technology and fittings are based on state-of-the art optic and electronic technology. New developments and innovations are constantly being integrated into the equipment. Thus, the diagrams, dimensions, and technical data used in this manual may have changed as a result of adapting the device to new information and improvements.

© Copyright 2016 BYK-Gardner GmbH
All rights reserved

No portion of the software, documentation or other accompanying materials may be translated, modified, reproduced, copied or otherwise duplicated (with the exception of a backup copy), or distributed to a third party, without prior written authorization from BYK-Gardner GmbH. In any case, this requires the prior written consent of BYK-Gardner.

BYK-Gardner GmbH offers no guarantee that the software will function without error or that the functions incorporated therein can be executed in all applications and combinations selected by you.

No liability other than as provided by law is assumed for direct or indirect damage sustained in association with the use of the instrument, the software or documentation.

BYK-Gardner GmbH reserves the right to update the software and written documentation without prior notice.

260 023 932 E 1604